

METAL  **EXTERIORS**

***AXIS PANEL
METAL SIDING***

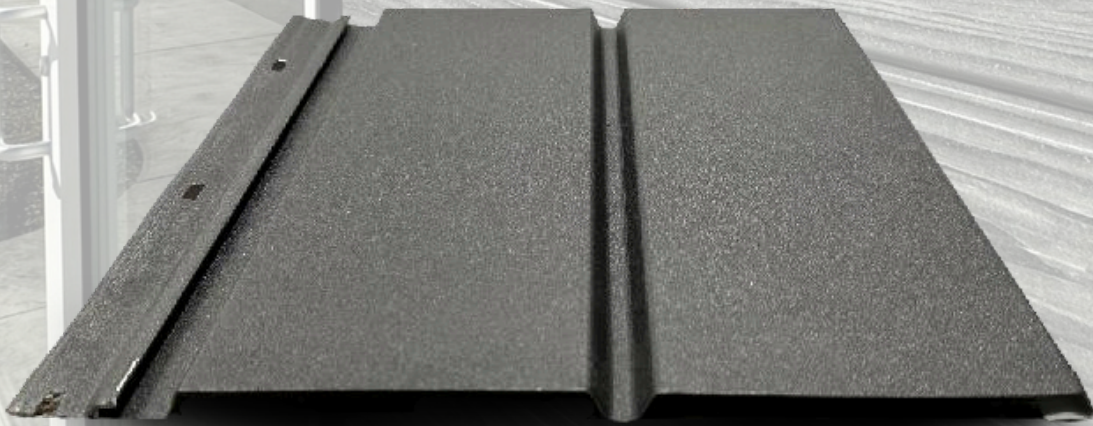

***INSTALLATION
GUIDE***

METAL  **EXTERIORS**



TABLE OF CONTENTS

OVERVIEW.....PAGE 2

HANDING AND STORAGE.....PAGE 3

QUALITY INSPECTIONS

HANDLING INSTRUCTIONS

STORAGE REQUIREMENTS

ESSENTIAL PREPARTION.....PAGE 4

REQUIRED TOOLS

SAFETY

AVOID COMMON ERRORS.....PAGE 5

CUTTING DO'S AND DON'TS

OIL CANNING

PREPPING THE WALLS

TRIM CHART.....PAGE 6

TRIM INSTALLATION.....PAGE 7-8

PANEL INSTALLATION.....PAGE 9-10

CARE & MAINTENANCE.....PAGE 11

CLOSING.....PAGE 12

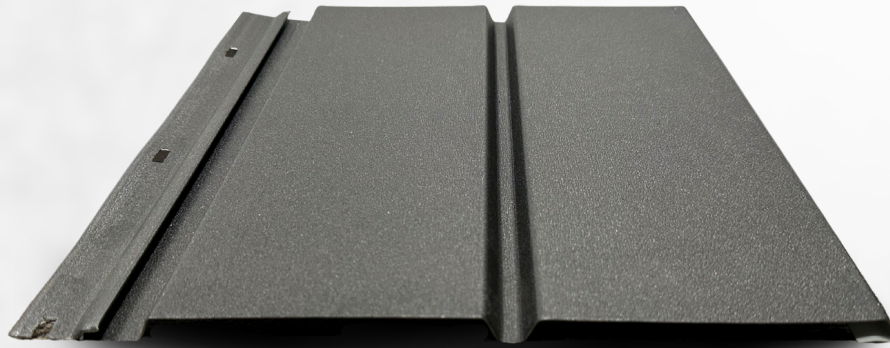

0.5 IN



10 IN. COVERAGE | 12 FT. LENGTHS

OVERVIEW

Thank you for taking the time to review the installation instructions for our Axis Panel.

In this guide we hope to give you all the information you will need to install this properly and efficiently.

In this guide we will share:

- The tools that are best suited for the job.
- Best cutting Practices.
- Safety Instructions.
- How to properly prep the wall.
- Diagrams on how to properly install the trims.
- How to properly install the panel.

It is our hope that this guide will serve as an additional tool in your belt for an easy install and reference for any questions that may arise throughout the course of your project.

For any additional questions that aren't covered by this guide, please contact us at 419-896-2200, or by email at Orders@metalexteriors.com. Our staff would love to help answer any questions that you may have.

HANDLING AND STORAGE



QUALITY INSPECTIONS

The Metal Exteriors team strives for accuracy in our orders and makes all effort to create timely customer service. Please check your order upon receiving it. In the event that you notice any discrepancies, please notify us right away so we can move swiftly to correct any mistakes that were made.

HANDLING INSTRUCTIONS

Handle your panels and trim with care to avoid damage. If you have longer panels, you may need more than one pick-up point when lifting them from the trailer or transferring them across the jobsite by hand. Trim and batten bundles may be heavy and should be broken down and separated to avoid harm to the worker when moving these to where they are needed. Please do not attempt to lift beyond your capacity as this could cause injury as well as damaged material.

STORAGE REQUIREMENTS

Metal Exteriors recommends having a covered area to store panels upon arrival at the jobsite. When ordering material, it is important to have panels delivered as close to the time they will be installed to avoid any damage from sitting on the jobsite. The longer panels are sitting the more likely they are to be damaged prior to installation.

If you do order materials in advance to have them ready when the time comes for installation, proper storage of the product is of utmost importance. Panels and trims should be stored in a covered, dry, and well-ventilated area. If panels are left in direct sunlight or exposed to moisture prior to installation it could cause a failure in the finish resulting in water spots or even surface rust. Panels should never be stored in direct contact with the ground.



REQUIRED TOOLS

To ensure a quality installation, it's important to have the right tools from the start. Whether you're a contractor or tackling the job yourself, the tools listed below will help you get it done efficiently and correctly.

- Screw Gun
- Hand Shears
- Tape measure
- Rivet tool
- Chalk line
- Hand Benders
- Straight edge
- Hammer
- Square
- *Left and right offset shears are recommended but are not required*
- *If using chalk, it is recommended that you use Blue and not Red due to the possibility of permanent staining or deterioration of the finish from "electric cell" affect.*

SAFETY

Whether the job you're doing is a roof or siding, safety should be your top priority. Safety hazards are all around a jobsite no matter what the job is and should be taken into careful consideration. Here are some tips to help you and your workers maintain a safe and injury free worksite.

- Maintain a clean clutter free workspace. Cut panels laying on the ground, extension or equipment cords.
- Beware of power lines when maneuvering panels.
- Always wear proper hearing and eye protection when cutting panels or trims. Gloves should be worn to protect you hands against sharp edges.
- Always be aware of your co-workers in the area. Make sure not to put them or yourself in danger.
- Be sure to follow state and local safety guidelines when installing this product.

AVOID COMMON ERRORS



CUTTING DO'S AND DON'TS

When cutting the panels in the field, here are some helpful tips to avoid damage. If you are using a circular saw to make your cuts, always cut from the back side of the panel.

This will ensure that no hot shavings come in contact with the finish and mar the paint. Always remember to wear proper eye and ear protection when cutting steel. Hand shears and Nibblers can also be used to cut these panels as well.

The same would apply to these options as well, all shavings should be removed from the panels to not damage the finish. Failure to remove these will result in rust stains on the panels. Never cut any panels on top of existing panels.

OIL CANNING

Oil canning is defined as a visual waviness in the flat area of metal panels. Many factors can contribute to the degree of natural and unnatural oil canning, including deflection due to thermal movement, misaligned substrates or framing and improperly aligned fasteners.

Deforming of the panel caused by improper installation or substrate should be addressed by the appropriate contractor.

To help reduce the appearance of oil canning, please follow installation guidelines and take the following steps:

- Nail or screw the Axis siding semi loosely on the wall.
- Using textured 26-gauge steel will also help lessen the appearance of oil canning.

PREPPING THE WALLS

Before you start your job, the first step is prepping the wall. This panel may only be installed on a solid substrate.

- For substrate, use a minimum of 7/16-inch OSB.
- Apply Zip System Flashing tape on the seams of the substrate for additional protection.
- Always cover the wall with house wrap after installing the substrate to protect against water damage.

Once these steps are complete you're ready to begin installing the trims for your siding.

TRIM CHART



Now that you're ready to start installing your trims, we've put together this reference chart to guide you.

For runs of more than 10' 3" that require multiple length of trim, overlap the pieces by 1-1/2". The material is thin enough that overlaps will not be easily noticeable if done correctly.

We recommend attaching trims using panhead screws. Be sure to drive screws in securely-tight enough to hold, but not so tight that they warp the trim or the wall.

Important: Remove strippable film from panels and trims before installation.

<p>OUTSIDE CORNER</p> <p>58STC(LN)(CLR) LN=10,12,14,16,18,20</p>	<p>INSIDE CORNER</p> <p>58STIC(LN)(CLR) LN=10,12,14,16,18,20</p>	<p>J CHANNEL</p> <p>58J(CLR)</p>	<p>RAT GUARD</p> <p>58RG(CLR)</p>
<p>DOUBLE ANGLE</p> <p>58DA(CLR)</p>	<p>DRIP FLASHING</p> <p>58DF(CLR)</p>	<p>3-1/2" SPLICE TRIM</p> <p>58STS3.5(CLR)</p>	<p>STARTER STRIP</p> <p>STSS(CLR)</p>
<p>FASCIA TRIM</p> <p>(x) = VARIABLE <ul style="list-style-type: none"> • 3-1/2" • 5-1/2" • 6" • 7-1/4" (CUSTOM BY REQUEST) F(LN)(CLR)</p>			

TRIM INSTALLATION



OUTSIDE CORNERS

Outside corners should be installed before fastening any panels, as the nailing flange should be hidden behind the finished panels. Outside corners have a built in J-Channel to receive the panels. (See Illustration 1)

- We do not recommend splicing outside or inside corners.(Custom sizes are available by request)

INSIDE CORNERS

Inside corners should be installed before fastening any panels, as the nailing flange should be hidden behind the finished panels. Inside corners have a built in J-Channel to receive the panels. (See Illustration 2)

- We do not recommend splicing outside or inside corners.(Custom sizes are available by request)

RAT GUARD (STARTER STRIP)

Rat Guard serves as the base trim at the bottom of the wall. To fasten it, use a panhead screw directly on the wall substrate or girt. After that, install the panel over the Rat Guard, resting on the trim's "ledge". (See Illustration 3)

DRIP FLASHING (DRIP CAP)

Drip flashing serves as a secondary option for base trim at the bottom of the wall. This trim should be used in applications shown in Illustration 4. To fasten it, use a panhead screw directly on the wall substrate or girt. After that, install the panel, resting on the trim's "ledge".(See Illustration 4)

The Drip Cap is also used over framed openings like doors and windows to allow water to run off without pooling or siphoning

FIGURE 1

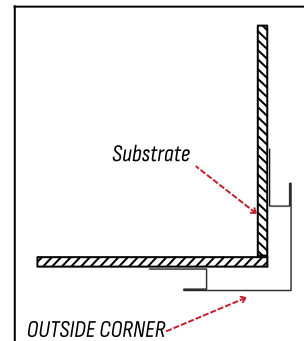

FIGURE 2

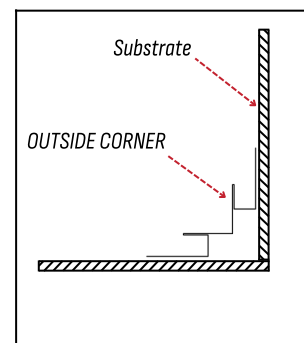

FIGURE 3

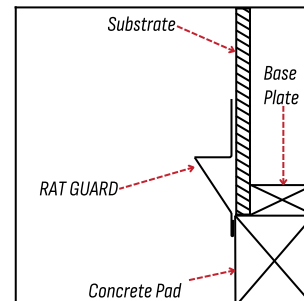
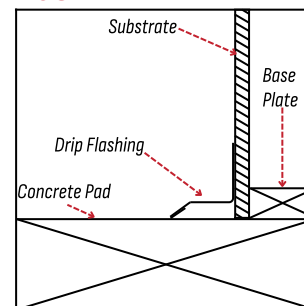

FIGURE 4



TRIM INSTALLATION



STARTER STRIP

A starter strip is the first piece of material installed at the base of a wall before siding panels are applied. Its main role is to lock and support the first course of siding so the installation is straight, secure, and properly aligned.

FIGURE 5

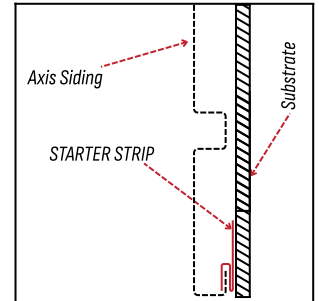

F&J COMBO TRIM

The F&J Combo trim is designed to replace both the J channel at the top of your wall as well as the F channel. To install, mark a line on your wall level with the bottom of your fascia board. This is where the very top of your F&J trim needs to be.

FIGURE 7

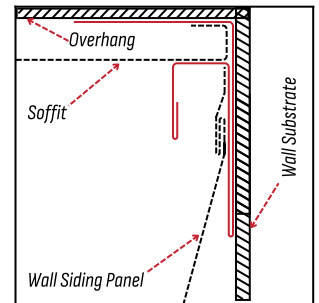

PANEL INSTALLATION



Familiarize yourself with all installation instructions before starting work. Before beginning installation, you should examine the substrate to ensure that all supporting members are straight, level, and plumb to avoid any panel distortion. Substructures should be designed to meet all necessary code requirements.

Some field cutting and fitting of panels and trims is to be expected by the installer and minor field corrections are a part of normal installation work.

It is the responsibility of the installer to ensure a suitable substrate prior to the application of the Metal Axis Siding

NOW WE CAN GET STARTED YOUR INSTALLATION

- Choose which side of the wall you want to start on. This is important because the panel overlap moves from panel to panel. **(If you start at the back and work forward, the overlap will only be visible from the back.)**
- Hook the first piece into the starter strip. Make sure the panels are fully locked along their entire length before fastening.
- After locking the panel, center the fasteners in the slots to allow for expansion and contraction. Begin fastening in the center of the panel and work toward the ends.
- Fasten every 16 inches along the nailing flange. **Do not over-tighten the screws, as this can cause oil canning. Drive fasteners straight and level to prevent distortion or buckling of the panel.**
- Each piece is notched on both the top and bottom for a clean overlap. The overlap margin is designed to be 1 inch. Always be mindful of which side you are cutting to avoid overlapping a cut edge.
- Do not stretch or force the panels up when fastening. Panel locks should be fully engaged; however, the panels should not be under vertical tension or compression when they are fastened.
- Stagger the siding end laps so that no two courses (rows of panels) are aligned vertically, unless separated by at least three courses.

When using tin snips, avoid closing the blades completely at the end of each stroke. This will produce a neater, cleaner cut.

PANEL INSTALLATION



FINISHING PANELS IN EAVES

When you're installing the Metal Axis siding horizontally or vertically and you reach the end of your run, you'll want to finish it neatly using a J-Channel or corner trim. In Most cases you will need to cut the panel to fit that final space.

- Measure from the top of the J-Channel to the bottom of the upper lock on the previous course of panels. Take measurements in several locations along the wall to ensure consistency.
- Once your panel is trimmed to the correct size, install and secure it in place using a color-matched screw.(Keep this screw as far up inside the J-channel as possible for a cleaner appearance.) After fastening, you can apply a bit of touch-up paint over the fastener head if needed.

Alternatively, if you prefer a method that doesn't rely on visible fasteners, there's also a technique to cut the panel so that it locks directly into the J-channel. It ensures a secure and clean finish without additional exposed hardware. This approach is demonstrated in the illustration below.

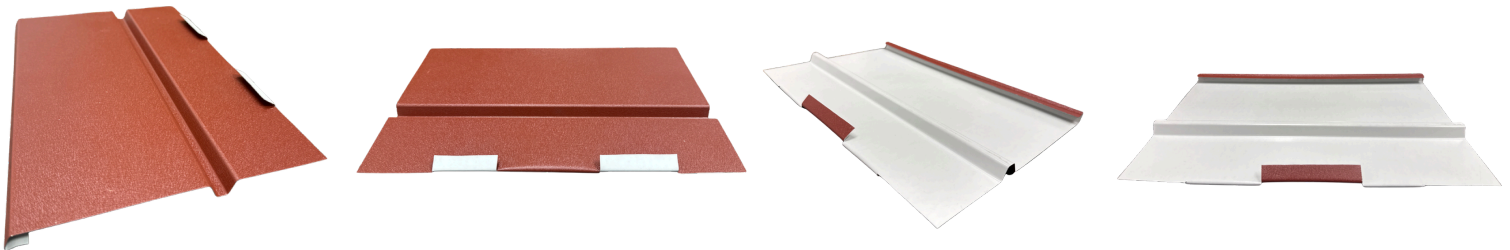

1. Using the pattern shown above, cut and bend retention tabs into the panel. Space these tab sets approximately every 3 to 4 feet along the length of the panel.
2. To ensure the correct locking angle, test fit the panel as needed. Achieving the proper angle—as shown in the diagram to the right—is key to secure placement.
3. This method relies on accurate cut placement. Take care during this step, as proper tab location and formation is essential for holding the panel securely in place.

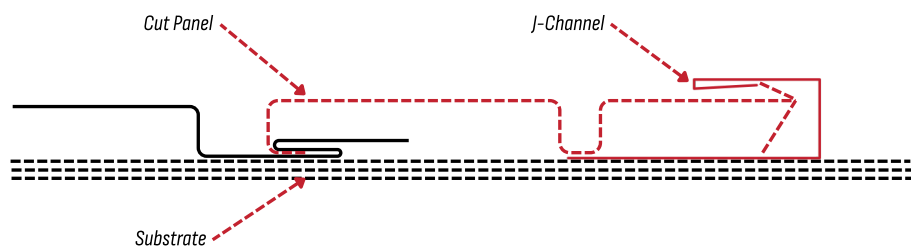

Care & Maintenance



While factory-applied finishes are so durable that they will last many years longer than ordinary paints, it is desirable to clean them thoroughly on a routine basis. Apparent discoloration of the paint may occur when it has been exposed in dirt-laden atmospheres for long periods of time.

Slight chalking may also cause some change in appearance in areas of strong sunlight. A good cleaning will generally restore the appearance of these coatings and render repainting unnecessary. An occasional light cleaning will also help maintain an aesthetically pleasing appearance.

To maintain the original finish of the coated product, the only regular maintenance necessary is that of annual washing. Mild solutions of biodegradable cleaner or household ammonia will aid in the removal of most dirt, and the following are recommended levels:

- 1. One cup of Simple Green[®], or other non-toxic biodegradable cleaner, which contain less than 0.5% phosphate, dissolved into two gallons of warm water. NOTE: The use of detergents containing greater than 0.5% phosphate is not recommended for use in general cleaning of building panels. NEVER BLEND CLEANSERS OR DETERGENTS WITH BLEACH.**
- 2. One cup of household ammonia dissolved into five gallons of water (room temperature).**

Working from the bottom to the top of the coated panels, the panels may be washed with either solution. The use of a well-soaked cloth, sponge, brush (with very soft bristles) and clean water rinse is advised. Do not use a pressure washer.

We do not recommend the use of scouring powders or industrial solvents, since these agents may damage the film. Solvent-containing cleaners such as Fantastic[®], however, are very effective and can be used without concern.

If mildew or other fungal growth is a problem and cannot be removed as outlined above, household bleach, mixed at a concentration of one cup of bleach to five gallons of water, along with one cup of a mild soap (e.g., Ivory) to aid wetting, is recommended.

Once the coated product is washed, thorough rinsing with clear water is necessary to eliminate the possibility of residue. Failure to remove all residues from these cleaning steps may damage the film.

Closing



Thank you for taking the time to review this installation guide.
It's our pleasure to assist you in making your dream a reality.

If you have any questions beyond this guide, please reach out to us using the contact information listed at the bottom of each page.

We're here to help every step of the way — from choosing the right panel to ensuring your project is finished with confidence. Our goal is to make the process as simple and stress-free as possible, so you can enjoy the results for years to come.

All Metal Exteriors panels are coated with AkzoNobel's premium paint system, backed by a lifetime limited warranty.

This warranty covers film integrity, chalk, and fade — ensuring your finish retains its appearance and protection over time.

It is transferable to the next property owner (once within the first ten years) and applies to surface coating only when installed according to manufacturer guidelines.

Thank you for choosing Metal Exteriors — where lasting quality and craftsmanship come together.
The Metal Exteriors Team

METAL  **EXTERIORS**

8511 SHILOH-NORWALK RD

SHILOH, OHIO 44878

419-896-2200

ORDERS@METAEXTERIORS.COM